

T-1³/₄ (5mm) Ultra Bright AlInGaP Amber LED Lamps

- LTL2F3VAK 8degree
- LTL2H3VAK 15degree
- LTL2P3VAK 22degree
- LTL2R3VAK 30degree

Features

- Very high luminous intensity output.
- Low power consumption.
- High efficiency.
- Versatile mounting on P.C. board or panel.
- I.C. compatible/low current requirements.
- Popular T-1 ³/₄ diameter.

Description

The source color devices are made with Aluminum Indium Gallium Phosphide on Gallium Arsenide light emitting diode.

The devices are made with water clear epoxy package, and with 8, 15, 22 and 30 degrees of viewing angle.

Application

Available for outdoor application.

- Message sign.
- Traffic sign.
- Automotive exterior lights.

Package Dimensions

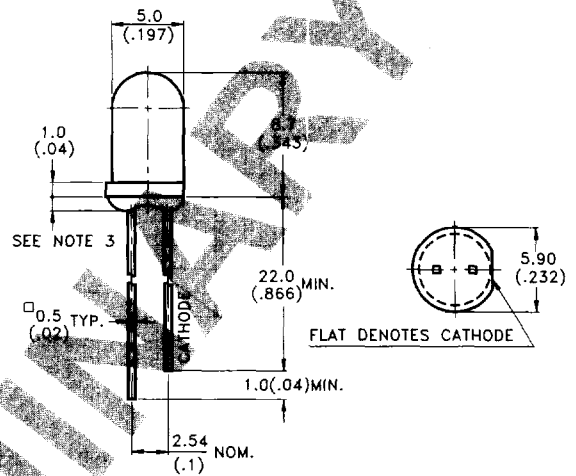

Devices

Part No. LTL	Lens		Source Color
	Color	Diffusion	
2F3VAK	Water Clear	Non-diffused	AlInGaP Amber
2H3VAK	Water Clear	Non-diffused	AlInGaP Amber
2P3VAK	Water Clear	Non-diffused	AlInGaP Amber
2R3VAK	Water Clear	Non-diffused	AlInGaP Amber

Absolute Maximum Ratings at Ta=25 °C

Parameter	Amber	Unit
Power Dissipation	130	mW
Peak Forward Current (1/10 Duty Cycle, 0.1ms Pulse Width)	160	mA
Continuous Forward Current	50	mA
Reverse Voltage	4	V
Operating Temperature Range	-40 °C to + 100 °C	
Storage Temperature Range	-55 °C to + 100 °C	
Lead Soldering Temperature [1.6mm(0.063")From Body]	260 °C for 5 Seconds	

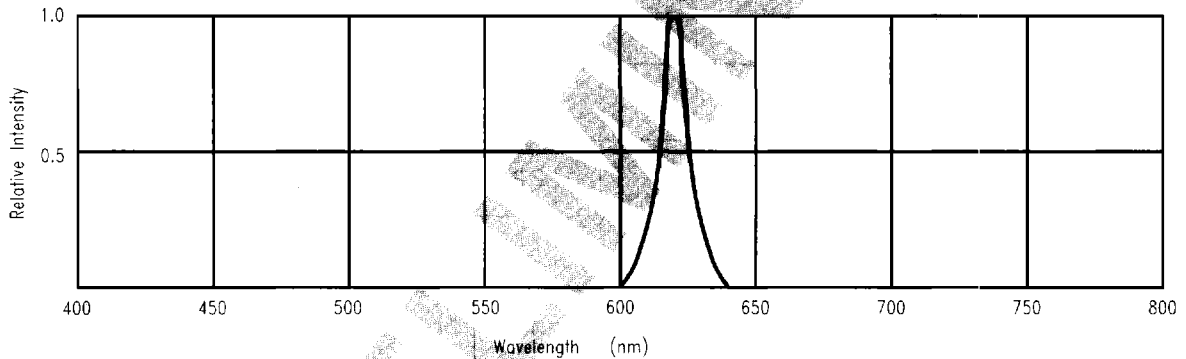

Fig.1 RELATIVE INTENSITY VS. WAVELENGTH

Electrical/Optical Characteristics and Curves at Ta=25 °C

Parameter	Symbol	Part No. LTL	Min.	Typ.	Max.	Unit	Test Condition
Luminous Intensity	Iv	2F3VAK	1800	7000	6400	mcd	If=20mA Note 1 Note 2
		2F3VAK-TU	1800		11200		
		2F3VAK-UV	3200				
		2H3VAK	1000	3600	3600		
		2H3VAK-ST	1000		6400		
		2H3VAK-TU	1800				
		2P3VAK	560	2300	2000		
		2P3VAK-RS	560		3600		
		2P3VAK-ST	1000				
		2R3VAK	320	1500	1120		
		2R3VAK-QR	320		2000		
		2R3VAK-RS	560				
Viewing Angle	$2\theta_{1/2}$	2F3VAK 2H3VAK 2P3VAK 2R3VAK		8 15 22 30		deg	Note 3 (Fig.6)
Peak Emission Wavelength	λ_P			623		nm	Measurement @ peak (Fig.1)
Dominant Wavelength	λ_d			612		nm	Note 6
Spectral Line Half-Width	$\Delta\lambda$			17		nm	
Forward Voltage	V _F			2.2	2.6	V	If = 20mA
Reverse Current	I _R				100	μA	V _R = 4V
Capacitance	C			40		PF	V _F =0, f=1MHZ

Notes:

- Luminous intensity is measured with a light sensor and filter combination that approximates the CIE eye-response curve.
- Luminous intensity rank classified products support two ranks.
- $\theta_{1/2}$ is the off-axis angle at which the luminous intensity is half the axial luminous intensity.
- Iv classification code is marked on each packing bag.
- The Iv guarantee should be added $\pm 15\%$.
- The dominant wavelength, λ_d is derived from the CIE Chromaticity Diagram and represents the single wavelength which defines the color of the device.

Typical Electrical/Optical Characteristic Curves (25 °C Ambient Temperature Unless Otherwise Noted)

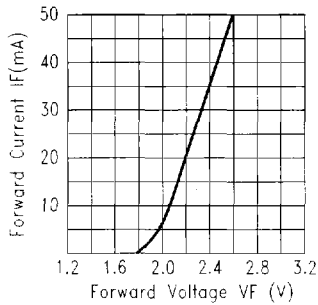

Fig.2 FORWARD CURRENT VS. FORWARD VOLTAGE

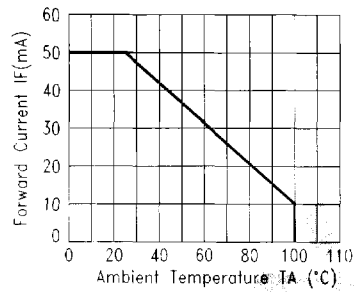

Fig.3 FORWARD CURRENT DERATING CURVE

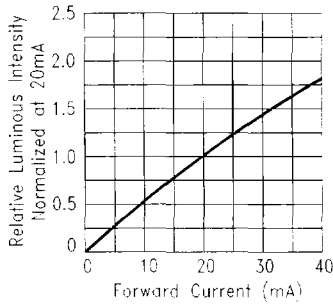

Fig.4 RELATIVE LUMINOUS INTENSITY VS. FORWARD CURRENT

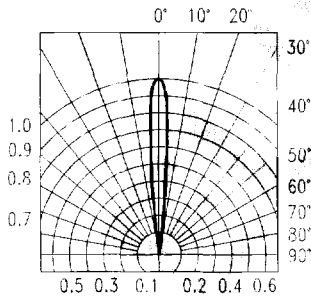

Fig.5-1 SPATIAL DISTRIBUTION

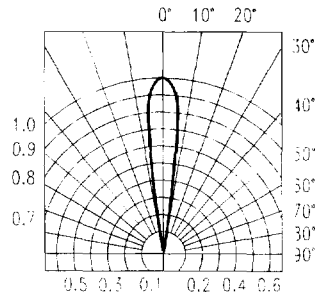

Fig.5-2 SPATIAL DISTRIBUTION

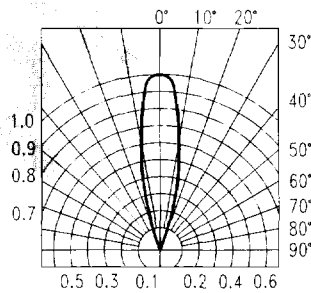

Fig.5-3 SPATIAL DISTRIBUTION

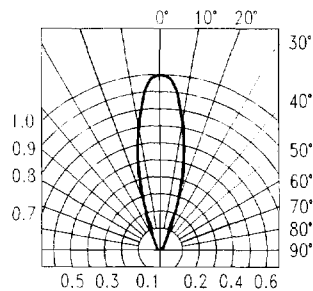

Fig.5-4 SPATIAL DISTRIBUTION

ULTRA BRIGHT LAMPS
CLUSTER & CHMSL